



VTTV/VTTR/VTTB

2-, 3-way and 3-way (bypass) zone valves

Valves for control of heating and cooling in fan-coil or chilled beams applications. The valves are intended to be used together with the thermal RTAN and RTAOM actuators. They are available as 2- and 3-way versions, as well as bypass versions. The valves have linear flow characteristics.

- ✓ Size DN15...DN20
- ✓ Kvs values 0.25...6.0
- ✓ Media temperature 2...95°C
- ✓ Pressure rating PN16
- ✓ No leakage

Function

The 2-way valve is closed when the stem is in its highest position and completely open when the stem is in its lowest position.

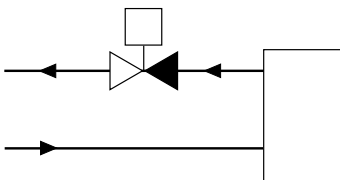

2-way valve

The 3-way valve is closed between port A and port AB (the ports opposite to one another) when the stem is in its highest position. In this position, the valve is also open between the bottom port B and the common supply port AB. When the stem is in its lowest position, the 3-way valve is completely open between port A and port AB and consequently closed between the bottom port B and the common port AB.

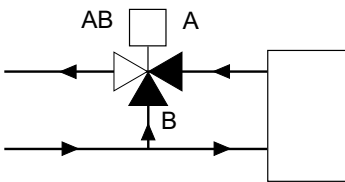

3-way valve

The bypass valve operates in the same way as the 3-way valve, but the connection to bottom port B has a different design.

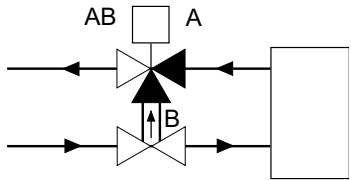

3-way bypass valve

No leakage in closed position

The valve has O-ring sealing between plug and seat, which makes it completely tight in closed position. This makes the valve very energy-efficient.

Installation

The 3-way and bypass valves can be used either as mixing valves or as diverting valves.

As mixing valves (2 inlets, 1 outlet), they must be mounted in the mixing point, according to the flow direction marks on the valve.

As diverting valves (1 inlet, 2 outlets), the maximum differential pressure allowed is one third of the normal value (see schedule).

- Before installation of the control valve, ensure that the pipe is clean. Make sure that pipe scale, metal chips, welding slag and other foreign materials are removed.
- For maximum efficiency and minimum wear, install the valve in a vertical position with the stem pointing upward. If the valve is mounted with the actuator on the side, more wear is caused to the valve packing box. The valve should never be mounted at an angle of more than 90°. At high media temperatures, the valve is to be mounted with the spindle to the side in order to minimise heating of the valve actuator.

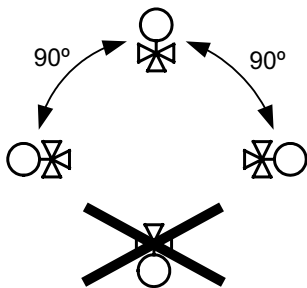

- Install the valve according to the fluid direction arrow shown on the valve.
- Make sure there is ample space above the valve to facilitate easy removal of the valve actuator.
- Fit a strainer/filter upstream of the valve to prolong the equipment's life span.
- A water quality according to VDI 2035 is recommended.

Technical data

Application	Heating systems, cooling systems, fan-coil units, ventilation systems
Pressure rating	PN16
Connection	BSP externally threaded according to ISO 228/1
Flow characteristics	Linear
Max. leakage	0 % of the kvs value
Media	Hot water, cold water, glycol-mixed water (max. 40 % glycol)
Media temperature	+2...+95 °C
Stroke	2.5 mm
Adapter	Included for RTAOM...actuators. No adapter is needed for RTAN... actuators.

Material

Body	Brass CW614N
Plug	PA + GF
Stem	PA + GF
Spring	Stainless steel
Packing box	PPO + GP
O-rings	FKM

2-way valves

Article	Nominal diameter	Kvs, A-AB	Kvs, B-AB	Max. diff. pressure	Actuator
VTTV15-0,25	DN15 (G 1/2)	0.25	-	250 kPa	RTAN, RTAOM100
VTTV15-0,4	DN15 (G 1/2)	0.4	-	250 kPa	RTAN, RTAOM100
VTTV15-0,6	DN15 (G 1/2)	0.6	-	250 kPa	RTAN, RTAOM100
VTTV15-1,0	DN15 (G 1/2)	1.0	-	250 kPa	RTAN, RTAOM100
VTTV15-1,6	DN15 (G 1/2)	1.6	-	250 kPa	RTAN, RTAOM100
VTTV20-2,5	DN20 (G 3/4)	2.5	-	250 kPa	RTAN, RTAOM100
VTTV20-4,0	DN20 (G 3/4)	4.0	-	80 kPa	RTAN140, RTAOM125
VTTV20-6,0	DN20 (G 3/4)	6.0	-	80 kPa	RTAN140, RTAOM125

3-way valves

Article	Nominal diameter	Kvs, A-AB	Kvs, B-AB	Max. diff. pressure	Actuator
VTTR15-0,25	DN15 (G 1/2)	0.25	0.25	250 kPa	RTAN, RTAOM100
VTTR15-0,4	DN15 (G 1/2)	0.4	0.4	250 kPa	RTAN, RTAOM100
VTTR15-0,6	DN15 (G 1/2)	0.6	0.6	250 kPa	RTAN, RTAOM100
VTTR15-1,0	DN15 (G 1/2)	1.0	0.8	250 kPa	RTAN, RTAOM100
VTTR15-1,6	DN15 (G 1/2)	1.6	1.0	250 kPa	RTAN, RTAOM100
VTTR20-2,5	DN20 (G 3/4)	2.5	1.6	250 kPa	RTAN, RTAOM100
VTTR20-4,0	DN20 (G 3/4)	4.0	2.5	80 kPa	RTAN140, RTAOM125
VTTR20-6,0	DN20 (G 3/4)	6.0	4.0	80 kPa	RTAN140, RTAOM125

3-way valves with bypass

Article	Nominal diameter	Kvs, A-AB	Kvs, B-AB	Max. diff. pressure	Actuator
VTTB15-0,25	DN15 (G 1/2)	0.25	0.25	250 kPa	RTAN, RTAOM100
VTTB15-0,4	DN15 (G 1/2)	0.4	0.4	250 kPa	RTAN, RTAOM100
VTTB15-0,6	DN15 (G 1/2)	0.6	0.6	250 kPa	RTAN, RTAOM100
VTTB15-1,0	DN15 (G 1/2)	1.0	0.8	250 kPa	RTAN, RTAOM100
VTTB15-1,6	DN15 (G 1/2)	1.6	1.0	250 kPa	RTAN, RTAOM100
VTTB20-2,5	DN20 (G 3/4)	2.5	1.6	250 kPa	RTAN, RTAOM100
VTTB20-4,0	DN20 (G 3/4)	4.0	2.5	80 kPa	RTAN140, RTAOM125
VTTB20-6,0	DN20 (G 3/4)	6.0	4.0	80 kPa	RTAN140, RTAOM125

Valve connections for copper tubing

Article	Description	Connection	Valve
1885136	Nut and olive	1/2", K12	CTV10, ZTV15, ZTR15, VTTV15, VTTR15, VTTB
1886274	Nut and olive	3/4", K15	CTV15, ZTV20 (kvs 2.0-2.5), ZTR (kvs 2.0-2.5), VTTV20 (kvs 2.5), VTTR20 (kvs 2.5), VTTB20 (kvs 2.5)
1884709	Nut and olive	3/4", K18	CTV15, ZTV20, ZTR20, VTTV20, VTTR20, VTTB20



188...

Steel pipe connection for VTTV/VTTR/VTTB and ZTV/ZTR valves

Article	Description	Connection	Valve
OVC-Z15	Pipe connection	1/2" (DN15)	VTTV/VTTR/VTTB, ZTV/ZTR (DN15)
OVC-Z20	Pipe connection	3/4" (DN20)	VTTV/VTTR/VTTB, ZTV/ZTR (DN20)



OVC-Z...

Suitable valve actuators

Article	Supply voltage	Control signal
RTAOM100-24	24 V AC/DC	On/off, NO
RTAOM100-24A	24 V AC	0...10 V DC, NO
RTAOM100-230	230 V AC	On/off, NO
RTAOM125-24	24 V AC/DC	On/off, NO
RTAOM125-230	230 V AC	On/off, NO
RTAN-24	24 V AC ± 10 %, 50/60 Hz	On/Off
RTAN-230	230 V AC ± 10 %, 50/60 Hz	On/Off
RTAN-24A	24 V AC ± 10 %, 50/60 Hz	0...10 V DC
RTAN140-24	24 V AC ± 10 %, 50/60 Hz	On/Off
RTAN140-230	230 V AC ± 10 %, 50/60 Hz	On/Off
RTAN140-24A	24 V AC ± 10 %, 50/60 Hz	0...10 V DC

VTTV/VTTR/VTTB valve + RTAOM or RTAN actuator = Valve closed against port A when actuator has no voltage applied

Dimensions

Measurements in mm unless otherwise specified.

2-way valves

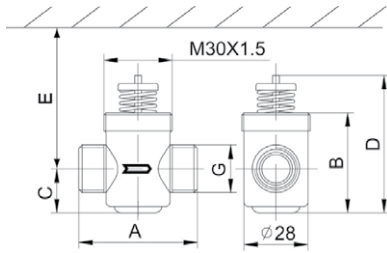

Model	G	A	B	C	D	E	Weight (g)
VTTV15	1/2"	52	46	20	62	≥ 130	110
VTTV20-2,5	3/4"	56	46	22	62	≥ 130	120
VTTV20-4,0/6,0	3/4"	78	59	35	75	≥ 130	420

3-way valves

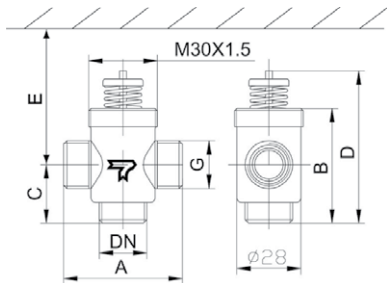

Model	G	A	B	C	D	E	Weight (g)
VTTR15	1/2"	52	52	26	68	≥ 130	116
VTTR20-2,5	3/4"	56	57	32	73	≥ 130	144
VTTR20-4,0/6,0	3/4"	78	70	45	86	≥ 130	430

3-way valves with bypass

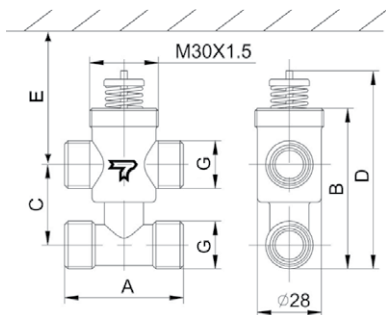

Model	G	A	B	C	D	E	Weight (g)
VTTB15	1/2"	52	70	35	62	≥ 130	164
VTTB20-2,5	3/4"	56	88	50	62	≥ 130	228
VTTB20-4,0/6,0	3/4"	78	82	44	75	≥ 130	520

Pressure drop diagram

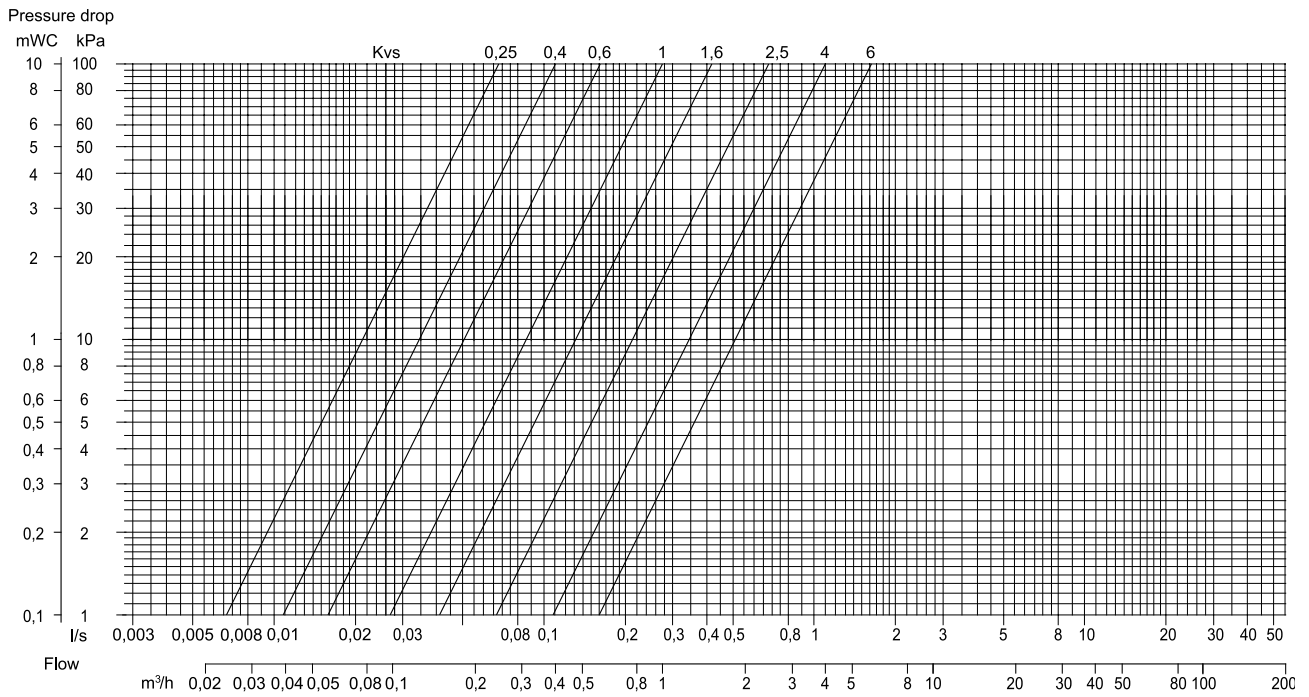

Example: calculation of kv value

If the pressure drop is 11 kPa (A) and the flow is 0.8 m³/h (B), the kv value is 2.5 (C). See the markings in the picture to the right.

